

Commissioning  
Page: 7

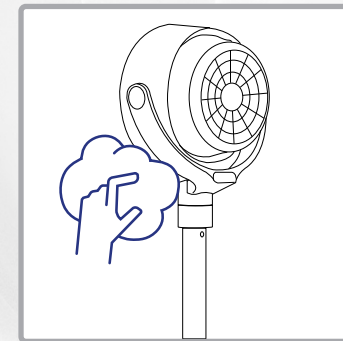

Cleaning  
Page: 10

# Welcome



**Please read all the information contained in these instructions for use. Keep the instructions for use in a safe place and pass them on to subsequent users. The device may only be used for its intended purpose in accordance with these instructions. Observe the safety instructions. The device is best operated with an RCD circuit breaker (max. 30mA).**



**Spare parts and accessories shop**  
<https://www.trisaelectronics.ch/en/zubehoer/>

# Table of Contents

<b>Safety instructions</b>	<b>4</b>	<b>Replacing the battery</b>	<b>10</b>
<b>Technical data</b>	<b>5</b>	<b>Cleaning</b>	<b>10</b>
<b>Device overview</b>	<b>6</b>	<b>Problems and causes</b>	<b>11</b>
<b>Commissioning</b>	<b>7</b>	<b>User information</b>	<b>12</b>
<b>Application</b>	<b>8</b>		

# Safety instructions



Do not cover the appliance while in operation with blankets, cloths or objects – fire hazard!

- Never spray insecticide onto the appliance, as this may damage it.
- Never direct the appliance's airflow directly at children / animals.
- Read all safety instructions, observe the instructions for use, keep them in a safe place and pass them on to subsequent users.
- The appliance is intended for domestic use, not for commercial use. Do not operate the appliance outdoors.
- Not for household waste. The device must be disposed of in accordance with local regulations.
- It is best to operate the device with an RCD (max. 30 mA).
- If the device is misused, operated incorrectly or repaired improperly, no liability can be accepted for any damage that occurs. In this case, the warranty claim is void.
- Never immerse the device in water or other liquids. No liquid must be allowed to enter the interior of the device (risk of short circuit).
- Check the device, power cord and extension cord for damage before each use. Never use damaged devices (including power cords) – have them repaired or replaced by the manufacturer, its service centre or qualified specialists. Never open the device yourself – risk of injury!
- Do not insert fingers or objects into device openings. Do not cover device openings.
- Avoid operating the device in the vicinity of flammable vapours.
- Children must not play with the device. Keep the device and power cord away from children under 8 years of age. Never leave the device unattended during operation. Packaging material (e.g. plastic bags) must be kept out of the reach of children.
- Mains connection: The voltage must correspond to the specifications on the device's type plate.
- Never carry or pull the device by the power cord. Do not kink, pinch or pull the power cord over sharp edges. Risk of short circuit due to cable breakage!
- Never place the device/connection cable on hot surfaces (hotplates) or near open flames. Do not expose the device to intense heat (heating sources, radiators, sunlight). Only extinguish burning devices with a fire blanket.
- Never pull the plug on the power cord or with wet hands. Unplug the device in the event of malfunctions during use, before refilling, before cleaning, before moving or after use. The plug must remain accessible at all times.
- Switch off unused/unattended devices and pull out the mains plug. Do not wrap the mains cable around the device.
- Only operate the device on a flat, stable, dry surface. Never attach it to a wall or ceiling.
- Do not operate/connect the appliance to a timer or remote-controlled switch.
- Children aged 8 years and above and persons with reduced physical, sensory or mental capabilities, or lack of experience and knowledge, may only use the device if they are supervised by a person responsible for their safety or if they have been shown how to use the device safely and understand the dangers involved. Cleaning and maintenance work must not be carried out by children without supervision.
- For safety reasons, do not use accessories that are not recommended/sold by the manufacturer.

# Technical data

Item no.: 9384.43

**220-240 V AC  
50/60Hz**

Input voltage

**0.76 (m<sup>3</sup>/min)/W**

Efficiency

**Approx. 1.5m**

Cable length

**29.3 x 17.5 x 90**

Dimensions (cm)

**3.8 kg**

Weight

**54 dB(A)**

Noise level

**4.97 m/s**

Max. air velocity

**17.71 m<sup>3</sup>/min**

Max. volume flow

## Power consumption

**23.4 W**

When on

**0.25 W**

In standby mode

**7,779 kWh/a**

Seasonal power  
consumption

# Device overview

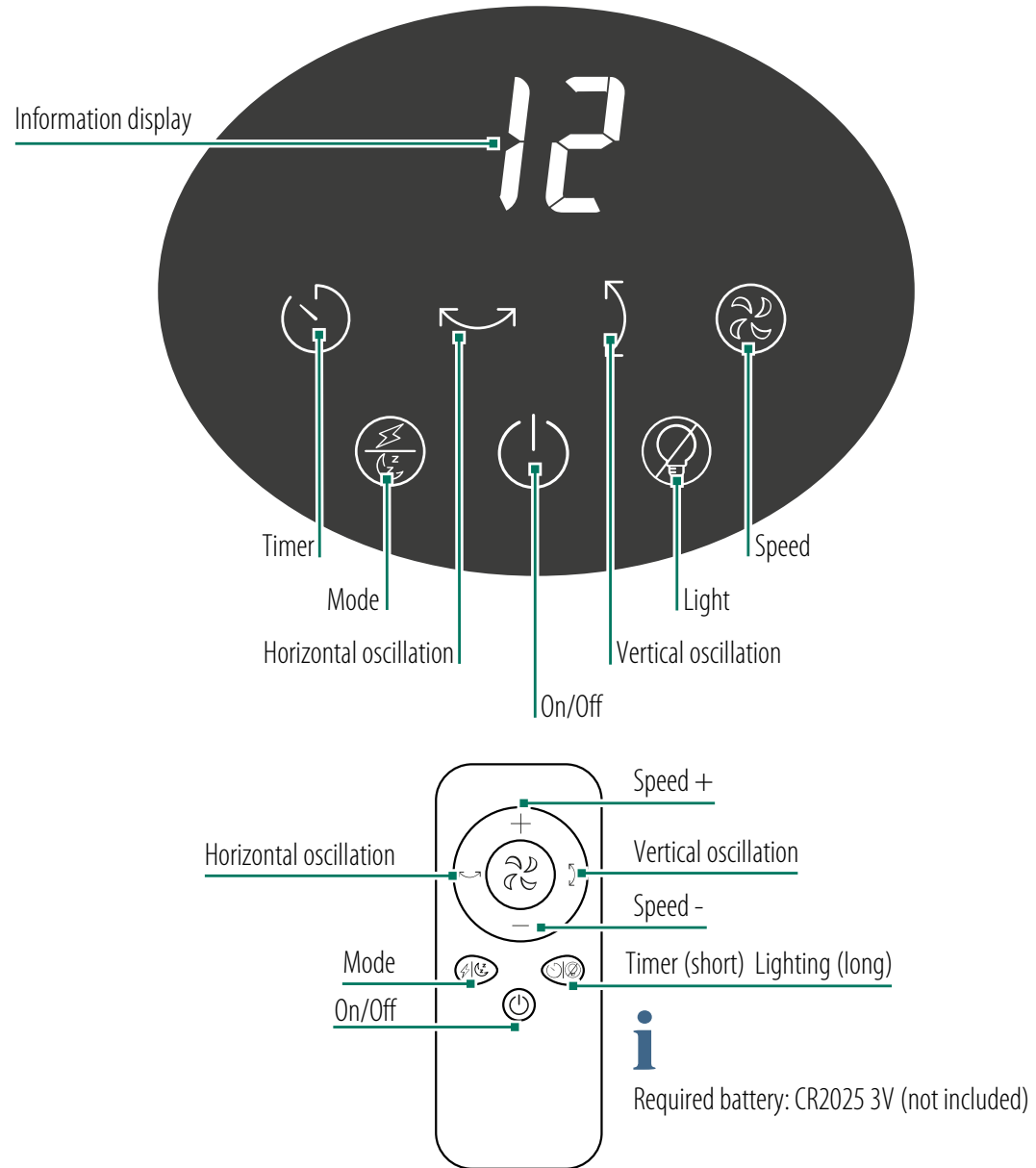
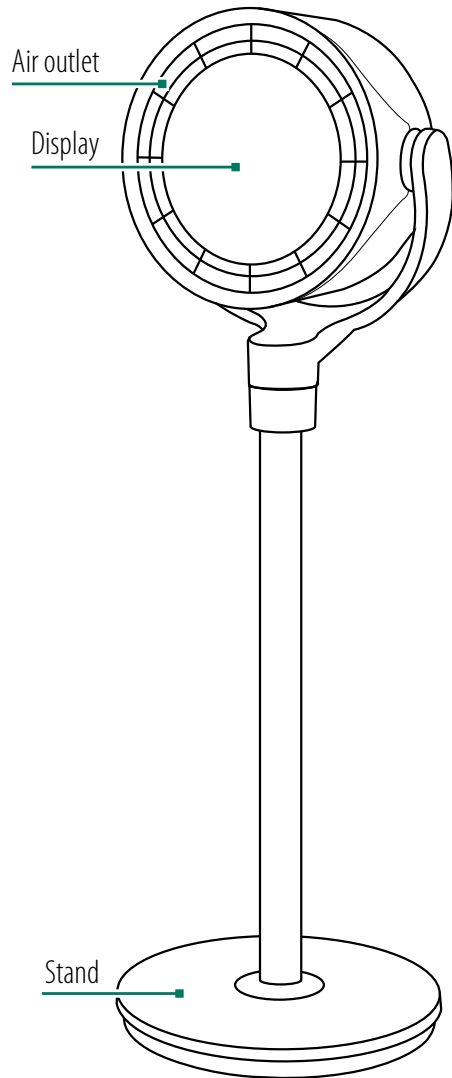

**Spare parts and accessories shop**  
<https://www.trisaelectronics.ch/en/zubehoer/>

# Commissioning

## 1. Device base

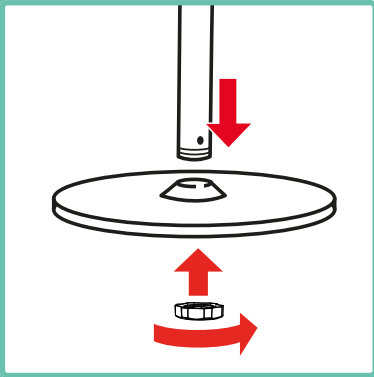

Push the pipe through the device base and screw it in place.

## 2. Intermediate pipe

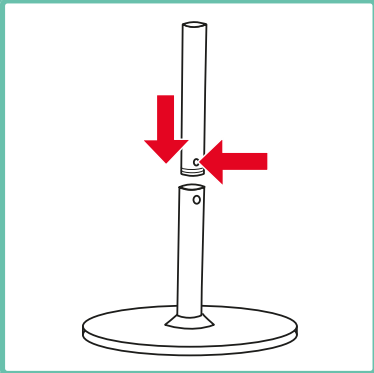

Insert the intermediate pipe and turn until it clicks into place.

**i** Skip this step to use the fan as a table fan.

## 3. Fan head

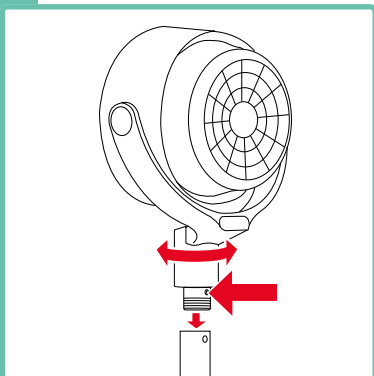

Fit the fan head and turn it until it clicks into place.

# Application

## 1. Plugging in the device

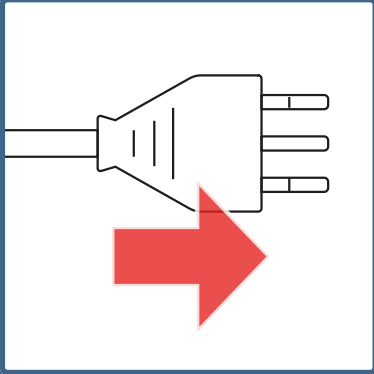

Plug in the device.

## 2. Switching on the device

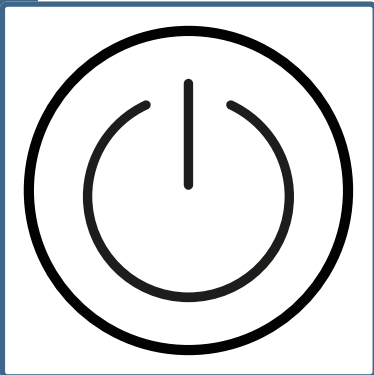

Switch on the device via the display.

## 3. Select fan speed

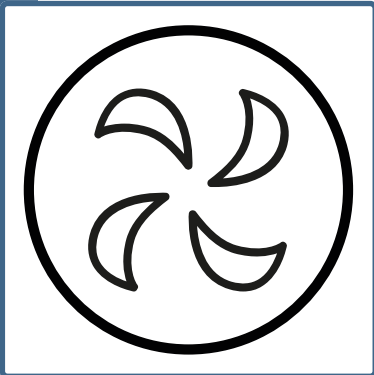

Select a fan speed (1-12) by pressing repeatedly.  
Can also be adjusted using the +/- buttons on the remote control.

## 4. Set vertical oscillation

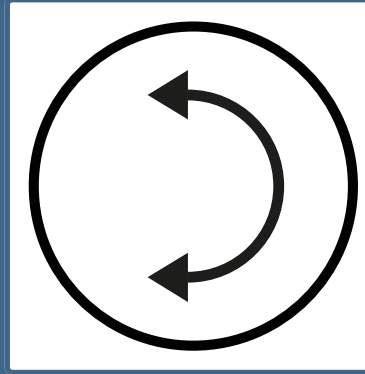

Select one of 3 modes:  
U1 = 30°,  
U2 = 60°,  
U3 = 120°

## 5. Set horizontal oscillation

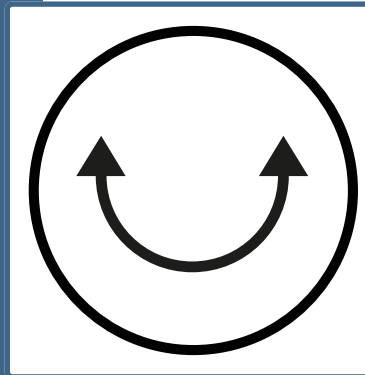

Select one of three modes.  
L1 = 60°,  
L2 = 90°,  
L3 = 120°

## 6. Select lighting

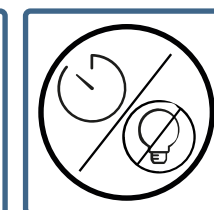
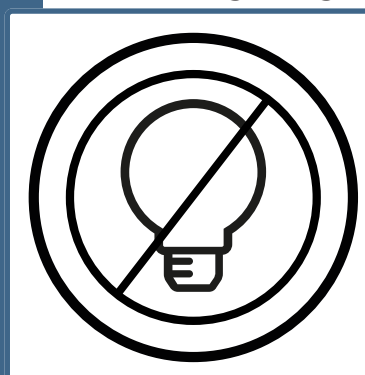

1x = switch on coloured decorative lighting  
2x = switch off display  
3x = Switch display back on

**i** First press 3s on the remote control to call up functions.

## 7. Set switch-off timer

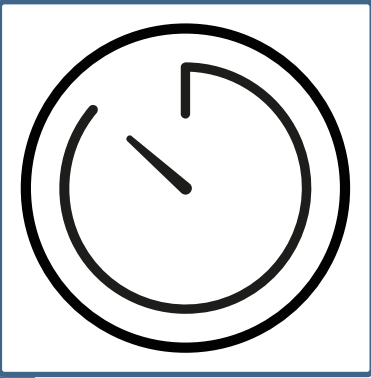

Press repeatedly to select a switch-off timer of 1 to 8 hours.

i

When the timer is activated, press again to display the remaining time.

## 8. Select turbo/night mode

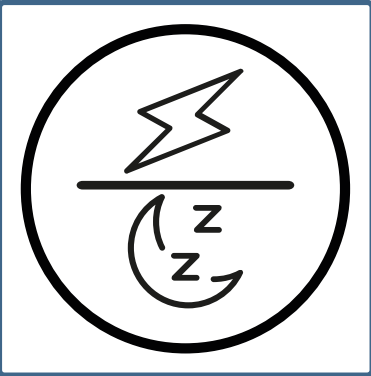

1x = Maximum fan speed  
2x = Activate night mode

i

In night mode, the device runs quietly, smoothly and without display lighting. The display shows: --

# Replacing the battery

## 1. Open the battery compartment

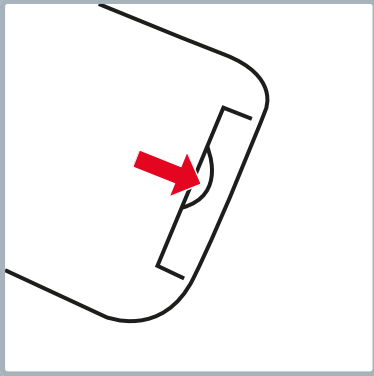

Open the battery compartment

## 2. Replace battery

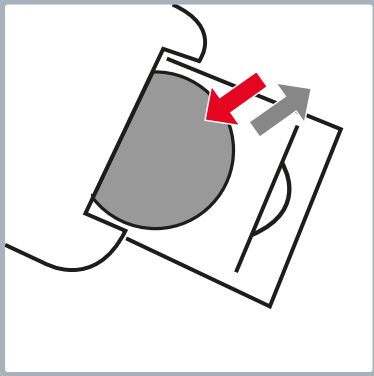

Required battery: CR2025 3V  
(Not included)

## 3. Close the battery compartment

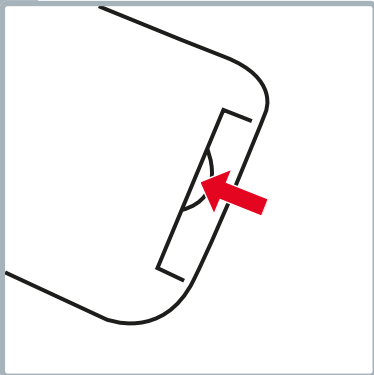

Close the battery compartment

# Cleaning

## 4. Cleaning the surface

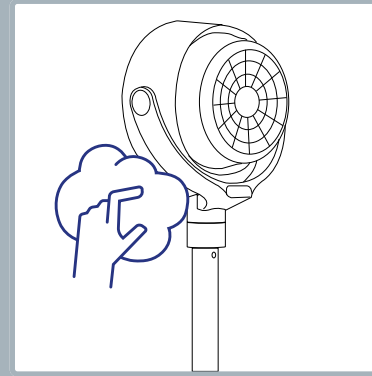

Wipe the surface of the appliance with a damp cloth and allow to dry.



Do not use abrasive cleaning agents or sponges.

# Problems and causes

<b>Problem/Cause</b>	<b>Solution</b>
Device does not start	Is the power supply connected? Has a wind speed been selected?
The fan wobbles during operation	Is it placed on a flat surface? Has correct assembly been checked?
Low/weak air flow	Weak wind speed selected?
The fan vibrates and makes noise	Placed on a flat surface? No objects at the air inlet/outlet? Rotor blade screwed on correctly? Fan cover screwed on correctly?
Remote control not working	Is the battery empty? Is the display within the field of vision of the remote control's infrared sensor?

# User information



We provide a 5-year warranty for this device from the date of purchase. The warranty covers the replacement or repair of a device with material or manufacturing defects. Replacement with a new device or return with a refund of the purchase price is not possible. The warranty does not cover normal wear and tear, commercial use, changes to the original condition, cleaning work, consequences of improper handling or damage caused by the purchaser or third parties, damage attributable to external circumstances or damage caused by batteries. The warranty requires that the defective device be sent in at the purchaser's expense with the warranty card dated and signed by the point of sale or with the purchase receipt.

## Disposal/environmental protection

Never dispose of this device in household waste, but in accordance with local regulations. Only use official collection points in your municipality. If devices are disposed of in an uncontrolled manner, harmful substances can escape and poison the food chain, flora and fauna. Your point of sale is obliged to take back old devices. Immediately render disused devices unusable. Unplug the power plug and cut the power cord.

## Distribution

**CH** Trisa Electronics AG  
Kantonsstrasse 121  
CH-6234 Triengen  
info@trisaelectronics.ch  
+41 41 933 00 30

**DE** Ernst Lorch KG  
Bildstockstraße 9  
D-72458 Albstadt  
HG@lorch-gruppe.com  
+49 (7431) 124 200

**AT** SCD Handels GmbH  
Unterhaus 33  
A-2851 Krumbach  
service@trisaelectronics.at  
+43 (2647) 4304070

**BG** Trisa Ltd.  
43A, Gorski Patnik Street  
BG- 1421 Sofia

**5** YEARS  
GUARANTEE

